



























Cresco API™ for Sterngold™

Implant Ø 3.3 mm, Narrow Platform		Cresco API™	REF 30308	REF 30508	REF 30808
Prosthetic Components		Laboratory Components		Includes Bridge Support in	
Impression Element and Pin  Bridge Screw 	Replica  Process Screw  Wax Tube 	Titanium 	Burnout 	Cobalt-Chrome 	

Implant Ø 3.75, 4.0, 5.0 mm, Regular Platform		Cresco API™	REF 30303	REF 30503	REF 30803
Prosthetic Components		Laboratory Components		Includes Bridge Support in	
Impression Element and Pin  Bridge Screw 	Replica  Process Screw  Wax Tube 	Titanium 	Burnout 	Cobalt-Chrome 	

Implant Ø 5.0, 6.0 mm, Wide Platform		Cresco API™	REF 30309	REF 30509	REF 30809
Prosthetic Components		Laboratory Components		Includes Bridge Support in	
Impression Element and Pin  Bridge Screw 	Replica  Process Screw  Wax Tube 	Titanium 	Burnout 	Cobalt-Chrome 	

Cresco™ restorative instruments for Sterngold™

Screwdrivers

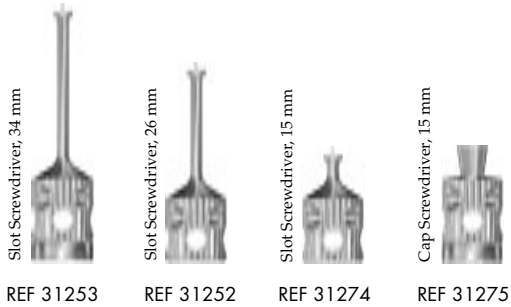

Slot Screwdriver, Long

RA Screwdrivers

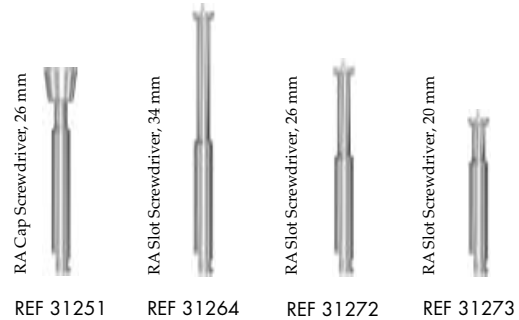

Instruments

REF 31276



Torque Ratchet Wrench with individual adjustment of the torque to 15, 20 and 35 Ncm

REF 31248



Counter Torque Key, flat grip

REF 22437



Forceps titanium, 94 mm

Sterngold™ is a trademark of Sterngold Dental LLC, USA.

Cresco™ and Cresco API™ are trademarks of Astra Tech AB, Sweden.